

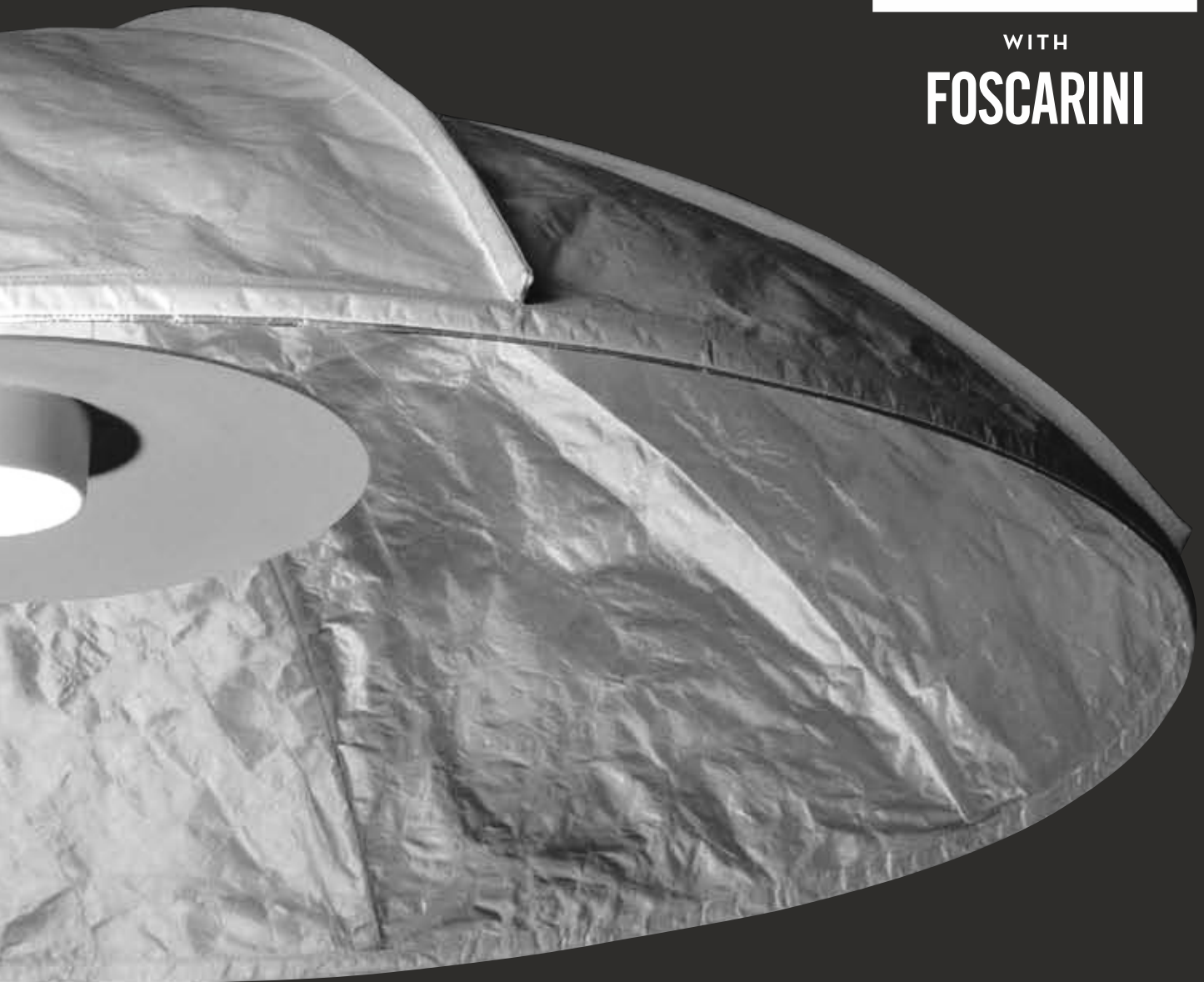

WITH  
**FOSCARINI**



PRICE-LIST  
2019 /EUROPE



-  
**PRICE-LIST**  
**TECHNICAL BOOK**  
**2019 EUROPE**

Valid from 1<sup>st</sup> January 2019



WITH  
**FOSCARINI**

# \_Diesel Living



## DIESEL LIVING WITH FOSCARINI

From rock to pop, from casual to vintage and from graphics to art. This is a completely new collection of lamps that speaks a multitude of languages, tells different stories and expresses an unmistakable style: the Diesel lifestyle. Ironic, unconventional, fun, fiery and creative. A way of being and of dressing that also becomes a way of furnishing: Diesel Living with Foscarini.

[foscarini.com](http://foscarini.com)



## LEGENDA

# FOSCARINI



1. **ENEC**  
The label ENEC (Electrical Certification concerning European Standard) is a voluntary label granted by third organizations. It certifies that a product complies to the EN 60598 standards and has been designed and manufactured by companies with an approved UNI EN ISO 9001 quality control system.



2. **CE**  
Declares that the manufacturer produces light fittings which comply with the requirements of the EN 60598.



3. **Classe I**  
Class I° luminaire: it's necessary to connect the device to the yellow/green protective conductor (earthing).



4. **Classe II**  
Light fittings whose safety is guaranteed only by the double and/or reinforced insulation of all parts, with no earth.

5. **IP protection degree**  
**IP20**: protected against the penetration of solid objects greater than 12 mm and non-protected against liquids.

6. The energy efficiency classes for light appliances set out by EU regulation no. 874/2012 are calculated on the basis of the Energy Efficiency Index (EEL) and range between A++ (maximum efficiency) and E (minimum efficiency).

7. **CSQ-IQNET**  
The CSQ-IQNET label is valid all over the world. It certifies that FOSCARINI runs a quality management system which complies with the UNI EN ISO 9001:2015 standard, to guarantee a high quality level for what concerns project, development, production and distribution of its products.

8. **CSQ ECO**  
This label is valid all over the world. It certifies that FOSCARINI runs an environmental management system which complies with the UNI EN ISO 14001:2015 standard in order to guarantee company's commitment to continual improvement of its environmental performances.



**Dimmer:**  
Please verify the compatibility of your bulb with the dimmer's wattage ranges, indicated on the dimmer itself, according to the kind of light source.

**Spare parts:**  
Lampshades, dimmer, protection glasses etc. that can be ordered as spare parts.

**Accessories:**  
Multiply canopies, kits decentralization that are not included but can be ordered if necessary.



**LED**  
It marks the models with integrated LED included in the lamp, which is the result of Foscarini designing and engineering.

## EXCERPT FROM THE SALES CONDITIONS

1. Our prices are net ex works.
2. The prices include: carton packaging, transformers for low tensions.  
Prices do not include bulbs, if not differently stated.
3. The prices here contained refer to materials complying with the technical standards of the market this price list is meant for. Any request for material complying with other standards shall be quoted separately.
4. Goods are carefully inspected and accurately packed before shipment, Foscarini Spa therefore declines any liability for transport damages.
5. The goods are dispatched at the buyer's risk, even if sent free domicile.
6. Claims must be notified by registered mail addressed to our head offices within 3 days from receipt of the goods.
7. Any litigation falls within cognisance of Venice / Italy Law-Court.
8. Dimensions and colours indicated have a tolerance due to the characteristic handwork of materials.
9. This price list can be subject to alteration without any notice.
10. Products images and configurations may vary from price book, catalogues and website from the actual merchandise, including but not limited to cords, cables, color, price, dimension, descriptions, details, dimmer.
11. Foscarini reserves the property of the goods until full payment of the same.
12. Prices are expressed in Euro vat excluded.
13. This price list replaces any previous one. This price list replaces any previous one.

## INTERACTIVE TOOLS

# Diesel Lamps app



**Diesel Lamps** an app designed for all design enthusiasts who wish to customise their surroundings with the unmistakable personality of Diesel with Foscarini models.

With captivating and emotional graphics and extremely user-friendly it allows users to insert lamps in rooms and settings which are caught on camera each time or picked from an archive of pictures. Available on the Apple Store and Play Store the Diesel Lamps app is a very effective tool that is extremely simple to use.

# Social media

Foscarini is present on all the main social networks with systems and languages suited to each individual channel and type of user:

- [Facebook](#) to create and maintain public relations, communicate news and projects, share news, images and films;
- [Instagram](#) to view projects and stimulate users to create images with Diesel with Foscarini models.
- [Twitter](#) publicise events, initiatives, news and links in brief, high impact messages;
- [Pinterest](#) to share images of Diesel with Foscarini models and initiatives, subdividing them into theme boards;
- [LinkedIn](#) to create and maintain relationships with sector operators and share professional contents





# foscarini.com

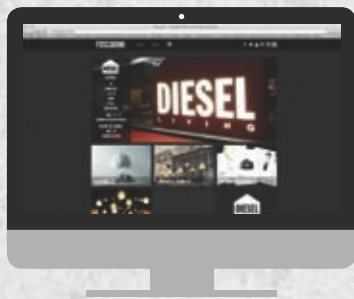

Packed with content, the [foscarini.com](http://foscarini.com) website keeps you up-to-date on our products, events and cultural initiatives at all times. The Video Stories section gives you the chance to find out about the concept and development of some of the most important Foscarini products. Information on the company, detailed technical data sheets for all models, assembly instructions, 2D and 3D designs as well as photometric curves can all be downloaded.

# myFoscarini



With the same spirit that provides new ideas in lighting design, Foscarini creates its own more efficient programs for customer and partner communication, for instance, [myFoscarini](#), a proprietary it platform, an absolutely innovative, highly flexible and transparent tool providing customers with complete information and full range of functions. With just a few clicks in myFoscarini you can:



















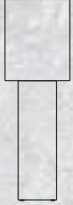

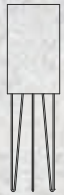



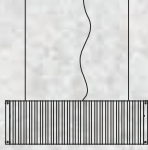

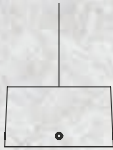







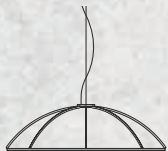

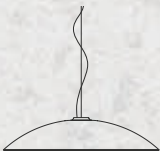

- check the availability of lamps and the shipping date
- Enter your orders, reserving lamps directly from Foscarini's central system
- track your order status

- consult sale conditions;
- download admin documents such as transport documents and invoices;
- prepare a quotation;
- download: images, logos, PDF and excel price lists assembly instructions, certifications and energy labels.

And all this 7 days a week, 24 hours a day.

If you haven't registered yet request your password from Foscarini Customer Care.



							
TAVOLO	<b>Duii</b> 10	<b>Duii mini</b> 10	<b>Fork</b> 11	<b>Fork maxi</b> 12	<b>Glass Drop</b> 13	<b>Hexx</b> 14	<b>Metafisica</b> 15
							
TERRA	<b>Fork</b> 16	<b>Pipe</b> 17	<b>Pylon</b> 18	<b>Tank</b> 19			
							
SOSPENSIONE	<b>Bell</b> 20	<b>Crash</b> 20	<b>Cage Mic</b> 21	<b>Cage</b> 22	<b>Container</b> 24	<b>Fork</b> 26	<b>Fork XL</b> 25
							
	<b>Gask</b> 28	<b>Glas</b> 29	<b>Glass Drop</b> 30	<b>Metal Glass</b> 31	<b>Mysterio</b> 32	<b>Pylon</b> 33	<b>Rock</b> 34
							
	<b>Smash</b> 35	<b>Space Fab</b> 36 <span style="background-color: yellow; border-radius: 50%; padding: 2px;">NEW</span>	<b>Tool</b> 37	<b>White Noise</b> 38 <span style="background-color: black; color: white; border-radius: 50%; padding: 2px;">LED</span>	<b>Wrecking Ball</b> 39 <span style="background-color: yellow; border-radius: 50%; padding: 2px;">NEW</span>		
							
SOFFITTO-PARETE	<b>Mysterio</b> 46	<b>Vent</b> 47 <span style="background-color: black; color: white; border-radius: 50%; padding: 2px;">LED</span>	PARETE	<b>Duii mini</b> 48	<b>Fork</b> 49	<b>Gask</b> 50	<b>Smash</b> 51
							
ACCESSORI	<b>Rosone multiplo</b> 40		<b>Kit Decentramento</b> 44		<b>Packing</b> 52	<b>Info</b> 55	

# DUII - MUI MINI

Diesel Creative Team 2011-2012



**LIGHT BULBS (NOT INCLUDED)**  
LED retrofit 1x10W R7s (78mm)

> specifications p. 55

**WEIGHT**  
**Duii**  
net kg 4,10  
  
**Duii mini**  
net kg 1,40

**MATERIALS**  
Pressed glass,  
aluminium, steel and  
laquered metal



adjustable arm and lampshade

Duii mini with personalized packaging

	COLOURS	ENERGY CLASS	CODE	€ VAT EXCLUDED
<b>Duii</b>	Grigio	A <sup>+</sup> , A	LI1811 25 E1	462,18
	Giallo		LI1811 50 E1	
<b>Duii mini</b>	Grigio	A <sup>+</sup> , A	LI1812 25 E1	294,12
	Giallo		LI1812 50 E1	

> pag. 48

Duii Giallo



Duii Grigio



Duii mini Giallo



Duii mini Grigio

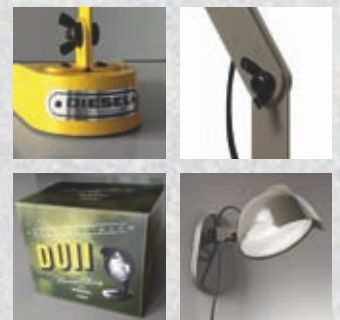

# FORK

Diesel Creative Team 2009

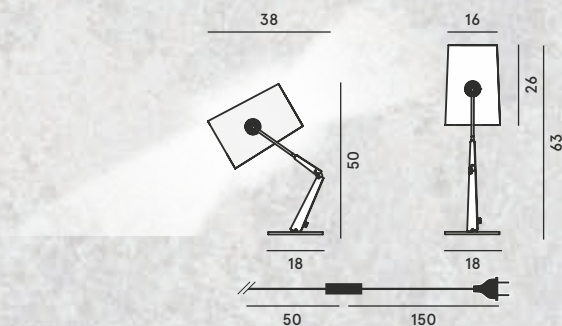

**LIGHT BULBS (NOT INCLUDED)**  
Max 1x48W R7s (78mm)  
dimmer included



Please verify the compatibility of your bulb with the dimmer's wattage ranges, indicated on the dimmer itself, according to the kind of light source.

> specifications p. 55

adjustable lampshade

**WEIGHT**  
net kg 2,40

**MATERIALS**  
Dyed linen,  
polycarbonate and  
coated steel



	COLOURS	ENERGY CLASS	CODE	€ VAT EXCLUDED
<b>Fork with dimmer</b>	Marrone/Grigio	A <sup>+</sup> , A, C	LI0411 25 E	683,19
	Marrone/Avorio		LI0411 50 E	
	Avorio/Grigio		LI0412 25 E	
	Avorio/Avorio		LI0412 50 E	
<b>Fork on/off</b>	Marrone/Grigio	A <sup>+</sup> , A, C	LI0411S 25 E	662,18
	Marrone/Avorio		LI0411S 50 E	
	Avorio/Grigio		LI0412S 25 E	
	Avorio/Avorio		LI0412S 50 E	
<b>SPARE PARTS</b> Lampshade Fork	Grigio		LI04DP 25 E	226,05
	Avorio		LI04DP 50 E	



# FORK MAXI

Diesel Creative Team 2014

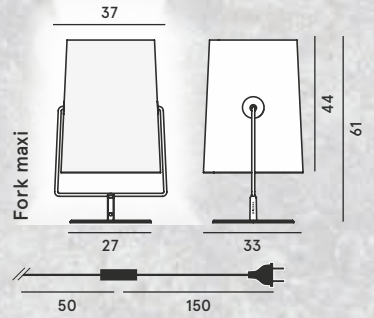

**LIGHT BULBS (NOT INCLUDED)**  
Max 1x120W R7s (118mm)  
dimmer included



Please verify the compatibility of your bulb with the dimmer's wattage ranges, indicated on the dimmer itself, according to the kind of light source.

> specifications p. 55

adjustable lampshade

**WEIGHT**  
**Fork maxi**  
net kg 3,80

**Fork mini**  
net kg 2,40

**MATERIALS**  
Dyed linen,  
polycarbonate and  
coated steel



	COLOURS	ENERGY CLASS	CODE	€ VAT EXCLUDED
<b>Fork maxi</b>	Marrone/Grigio*	A <sup>+</sup> , A, C	LI0413 25 E	701,68
	Marrone/Avorio*		LI0413 50 E	
<b>SPARE PARTS</b> Lampshade Fork maxi	Grigio		LI04DG 25 E	355,46
	Avorio		LI04DG 50 E	

\* limited stock available

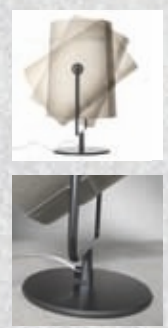
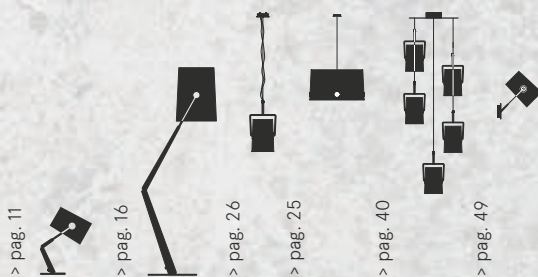

## GLASS DROP

Diesel Creative Team 2014

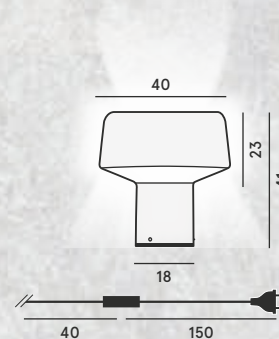
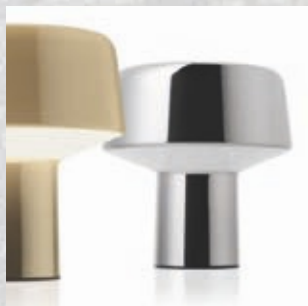

### LIGHT BULBS (NOT INCLUDED)

Max 1x150W E27  
dimmer included



Please verify the compatibility of your bulb with the dimmer's wattage ranges, indicated on the dimmer itself, according to the kind of light source.

> specifications p. 55

**WEIGHT**  
net kg 7,90

**MATERIALS**  
Metallized blown  
glass and varnished  
steel

**CERTIFICATIONS**  



**IP 20**

	COLOURS	ENERGY CLASS	CODE	€ VAT EXCLUDED
<b>Glass Drop</b>	Cromo	A <sup>+</sup> , A	LI3011 78 E	798,32

### SPARE PARTS

Glass Glass Drop	Cromo		LI30VT 78 E	627,73
------------------	-------	--	-------------	--------

> pag. 30

> pag. 40

Cromo



on



off

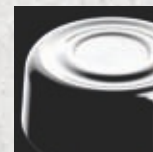

# HEXX

Diesel Creative Team 2014

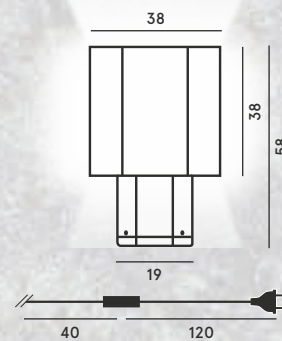

**LIGHT BULBS (NOT INCLUDED)**

Max 1x105W E27  
+ 1x100W E27 PAR 30

> specifications p. 55

**WEIGHT**

net kg 6.30

**MATERIALS**

Varnished steel and  
silkscreen-printed  
glass



double switch

	COLOURS	ENERGY CLASS	CODE	€ VAT EXCLUDED
Hexx	Nero*	A <sup>+</sup> , A	LI3411 20 E	514,29
	* limited stock available			





# METAFISICA

Diesel Creative Team 2014

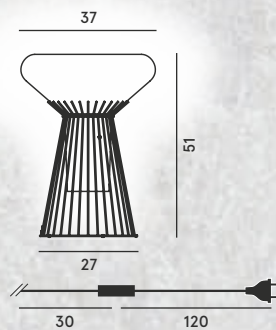
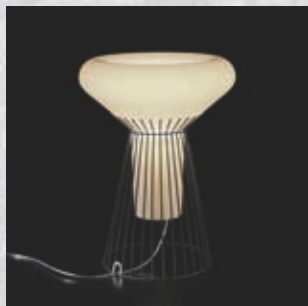

#### LIGHT BULBS (NOT INCLUDED)

Max1x150W E27  
dimmer included

**WEIGHT**  
net kg 5,50

**MATERIALS**  
Blown glass and  
varnished steel



Please verify the compatibility of your bulb with the dimmer's wattage ranges, indicated on the dimmer itself, according to the kind of light source.

> specifications p. 55

	COLOURS	ENERGY CLASS	CODE	€ VAT EXCLUDED
<b>Metafisica</b>	Avorio	A <sup>+</sup> , A	LI3311 50 E	652,10
<b>SPARE PARTS</b>				
Glass Metafisica	Avorio		LI33VT 50 E	281,51

Avorio



# FORK

Diesel Creative Team 2009

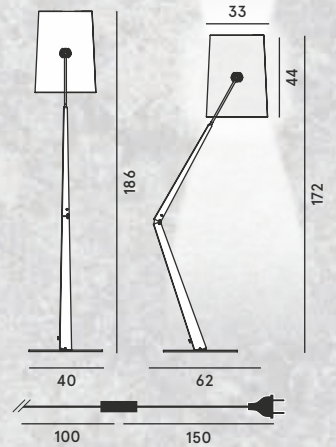

**LIGHT BULBS (NOT INCLUDED)**  
Max 1x120W R7s (118mm)  
dimmer included

**WEIGHT**  
net kg 11,50

**MATERIALS**  
Dyed linen,  
polycarbonate and  
coated steel



Please verify the compatibility of your bulb with the dimmer's wattage ranges, indicated on the dimmer itself, according to the kind of light source.

> specifications p. 55

adjustable lampshade

	COLOURS	ENERGY CLASS	CODE	€ VAT EXCLUDED
<b>Fork with dimmer</b>	Marrone/Grigio	A <sup>+</sup> , A, C	LI0431 25 E	974,79
	Marrone/ Avorio		LI0431 50 E	
	Avorio/Grigio		LI0432 25 E	
	Avorio/Avorio		LI0432 50 E	
<b>Fork on/off</b>	Marrone/Grigio	A <sup>+</sup> , A, C	LI0431S 25 E	949,58
	Marrone/ Avorio		LI0431S 50 E	
	Avorio/Grigio		LI0432S 25 E	
	Avorio/Avorio		LI0432S 50 E	
<b>SPARE PARTS</b>	Lampshade Fork			
		Grigio	LI04DG 25 E	355,46
		Avorio	LI04DG 50 E	



# PIPE

Diesel Creative Team 2011

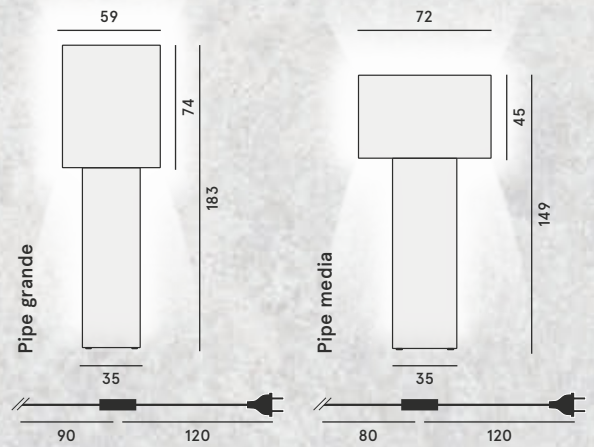

**LIGHT BULBS (NOT INCLUDED)**  
Max 2x150W E27  
dimmer included

 Please verify the compatibility of your bulb with the dimmer's wattage ranges, indicated on the dimmer itself, according to the kind of light source.

> specifications p. 55

double switch

**WEIGHT**  
**Pipe grande**  
net kg 8,50

**Pipe media**  
net kg 9,00

**MATERIALS**  
Dyed natural linen,  
PVC and coated  
metal



	COLOURS	ENERGY CLASS	CODE	€ VAT EXCLUDED
<b>Pipe grande</b>	Bianco	A <sup>+</sup> , A	LI1431 10 E	1.647,05
	Nero		LI1431 20 E	1.957,98
	Mesh		LI1431 21 E	1.957,98
<b>Pipe media</b>	Bianco	A <sup>+</sup> , A	LI1432 10 E	1.613,44
	Nero		LI1432 20 E	1.983,20
	Mesh		LI1432 21 E	1.983,20



# PYLON

Diesel Creative Team 2014

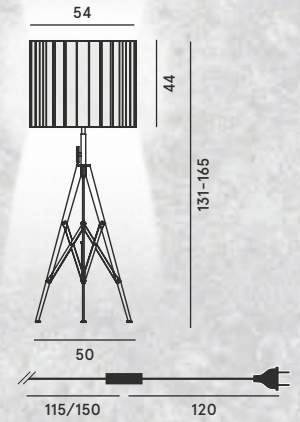

**LIGHT BULBS (NOT INCLUDED)**

Max 1x116W E27  
dimmer included



Please verify the compatibility of your bulb with the dimmer's wattage ranges, indicated on the dimmer itself, according to the kind of light source.

> specifications p. 55

extendable stem

**WEIGHT**

net kg 8,80

**MATERIALS**

Dyed linen, PVC and varnished steel



	COLOURS	ENERGY CLASS	CODE	€ VAT EXCLUDED
<b>Pylon</b>	Nero/Avorio*	A <sup>+</sup> , A	LI3731 50 E	1.193,28

**SPARE PARTS**

Lampshade Pylon	Avorio		LI37D 50 E	563,03
	* limited stock available			

> pag. 33



# TANK

Diesel Creative Team 2017

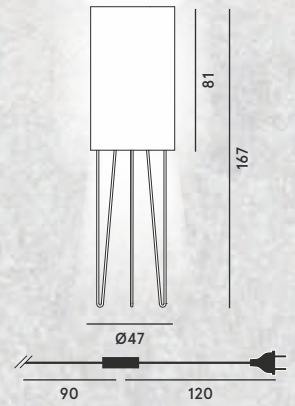

**LIGHT BULBS (NOT INCLUDED)**  
Max2x150W E27  
dimmer included

**WEIGHT**  
net kg 8,00

**MATERIALS**  
Fabric and  
varnished steel



Please verify the compatibility of your bulb with the dimmer's wattage ranges, indicated on the dimmer itself, according to the kind of light source.

	COLOURS	ENERGY CLASS	CODE	€ VAT EXCLUDED
Tank	Rust	A <sup>+</sup> , A	LI4631-52E	1.226,89



# BELL - CRASH

Diesel Creative Team 2014

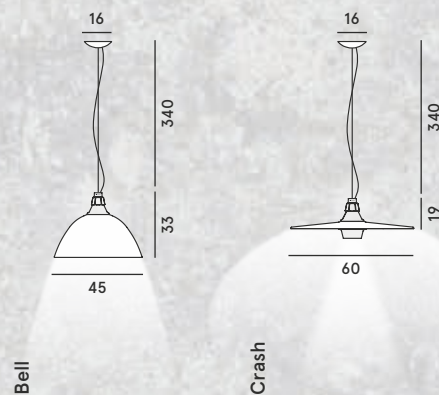

**LIGHT BULBS (NOT INCLUDED)**  
Max 1x57W E27

> specifications p. 55

**WEIGHT**

**Bell**  
net kg 2,20

**Crash**  
net kg 2,20

**MATERIALS**

Blown sandblasted  
glass and varnished  
aluminium



	COLOURS	ENERGY CLASS	CODE	€ VAT EXCLUDED
Bell	Alluminio	A <sup>+</sup> , A	LI2872 77 E	530,25
	Bronzo		LI2872 55 E	
Crash	Alluminio	A <sup>+</sup> , A	LI2871 77 E	530,25
	Bronzo		LI2871 55 E	
Bell h. 10 m •	Alluminio	A <sup>+</sup> , A	LI2872-77-E10	570,29
	Bronzo		LI2872-55-E10	
Crash h. 10 m •	Alluminio	A <sup>+</sup> , A	LI2871-77-E10	570,29
	Bronzo		LI2871-55-E10	

**SPARE PARTS**

Lampshade Bell	Alluminio	LI28D2 77 E	252,10
	Bronzo	LI28D2 55 E	
Lampshade Crash	Alluminio	LI28D1 77 E	252,10
	Bronzo	LI28D1 55 E	

**ACCESSORIES**

Decentralization kit ◊	Decentralization for steel cables	KIT DEC B	28,00
	Decentralization for steel cables with canopy	KIT DEC F	49,00
	Canopy electrical decentralization	KIT DEC M	87,00

• On demand: lead times to be checked with the sales department

◊ Specifications see page 44

Bell alluminio



Bell bronzo



Crash alluminio



Crash bronzo



# CAGE MIC

Diesel Creative Team 2009

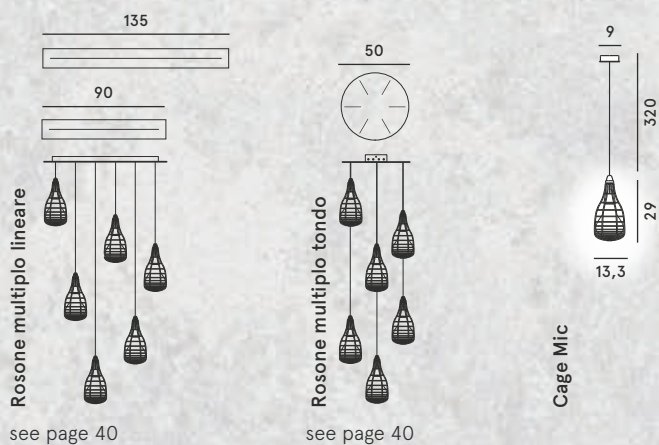

**LIGHT BULBS (NOT INCLUDED)**  
Max 1x33W G9

> specifications p. 55

**WEIGHT**  
net kg 1,30

**MATERIALS**  
Blown glass and  
coated steel



	COLOURS	ENERGY CLASS	CODE	€ VAT EXCLUDED
<b>Cage Mic</b>	Bianco	A <sup>+</sup> , A, C	LI0277-10-E1	379,00
	Nero		LI0278-10-E1	
<b>Cage Mic h. 10 m ♦</b>	Bianco	A <sup>+</sup> , A, C	LI0277-10E101	419,06
	Nero		LI0278-10E101	
<b>SPARE PARTS</b>				
Glass Cage Mic	Bianco		LI02VM 10 E	89,07
<b>ACCESSORIES</b>				
Decentralization kit ♦	Decentralization for power cable		KIT DEC C	33,00
	Canopy electrical decentralization		KIT DEC M	87,00

• On demand: lead times to be checked with the sales department

♦ Specifications see page 44

> pag. 22

> pag. 40

Cage mic bianco



Cage mic nero



Nero



Bianco



# CAGE

Diesel Creative Team 2009

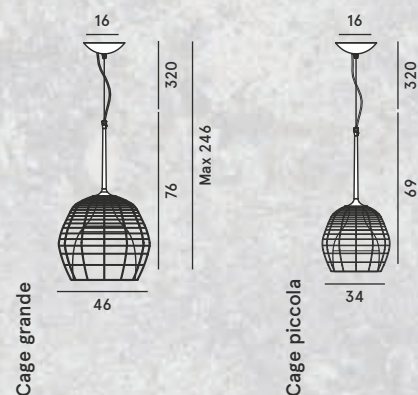
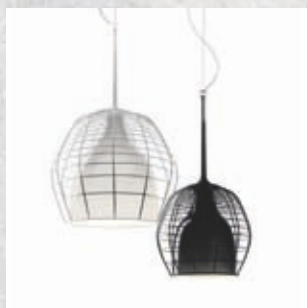

## LIGHT BULBS (NOT INCLUDED)

**Cage grande / Cage piccola**  
Max 1x105W E27

> specifications p. 55

## WEIGHT

**Cage grande**  
net kg 4,50

**Cage piccola**  
net kg 3,00

## MATERIALS

Laquered blown  
glass, coated steel  
and chromed metal



	COLOURS	ENERGY CLASS	CODE	€ VAT EXCLUDED
<b>Cage grande</b>	Bianco/Bianco	A <sup>+</sup> , A	LI0271 10 E	773,95
	Bianco/Nero		LI0271 20 E	
	Nero/Bianco		LI0272 10 E	
	Nero/Nero		LI0272 20 E	
	Marrone/Bronzo		LI0270 50 E	1.034,45
<b>Cage piccola</b>	Bianco/Bianco	A <sup>+</sup> , A	LI0274 10 E	647,90
	Bianco/Nero		LI0274 20 E	
	Nero/Bianco		LI0275 10 E	
	Nero/Nero		LI0275 20 E	
	Marrone/Bronzo		LI0279 50 E	832,78
<b>Cage grande h. 10 m •</b>	Bianco/Bianco	A <sup>+</sup> , A	LI0271-10-E10	813,99
	Bianco/Nero		LI0271-20-E10	
	Nero/Bianco		LI0272-10-E10	
	Nero/Nero		LI0272-20-E10	
	Marrone/Bronzo		LI0270-50-E10	1.074,49
<b>Cage piccola h. 10 m •</b>	Bianco/Bianco	A <sup>+</sup> , A	LI0274-10-E10	687,96
	Bianco/Nero		LI0274-20-E10	
	Nero/Bianco		LI0275-10-E10	
	Nero/Nero		LI0275-20-E10	
	Marrone/Bronzo		LI0279-50-E10	872,84

> pag. 21

> pag. 40

Cage grande



Cage piccola



Bianco, Nero



Bronzo





# CAGE

Diesel Creative Team 2009

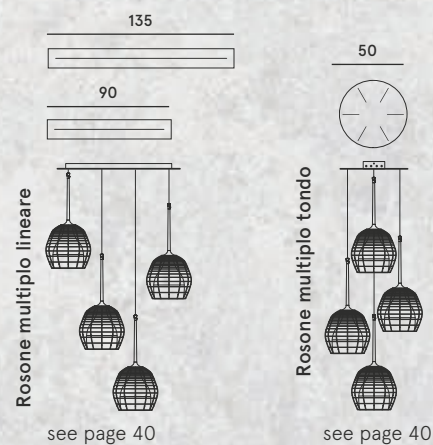

SPARE PARTS	COLOURS	ENERGY CLASS	CODE	€ VAT EXCLUDED
Glass Cage grande	Bianco		LI02VG 10 E	279,83
	Nero		LI02VG 20 E	
	Bronzo		LI02VG 50 E	452,10
Glass Cage piccola	Bianco		LI02VP 10 E	206,72
	Nero		LI02VP 20 E	
	Bronzo		LI02VP 50 E	290,76
<b>ACCESSORIES</b>				
Decentralization kit ◊	Decentralization for steel cables		KIT DEC B	28,00
	Decentralization for steel cables with canopy		KIT DEC F	49,00
	Canopy electrical decentralization		KIT DEC M	87,00

- On demand: lead times to be checked with the sales department
- ◊ Specifications see page 44

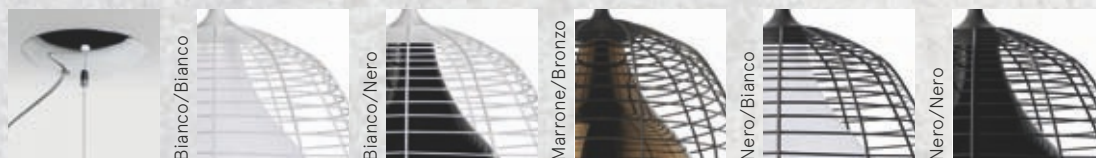

# CONTAINER

Diesel Creative Team 2016

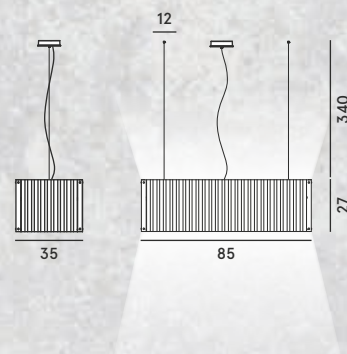
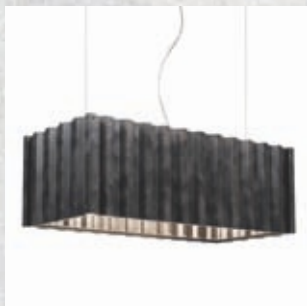

**LIGHT BULBS (NOT INCLUDED)**  
Max 2x30W E27

**WEIGHT**  
net kg 10,00

**MATERIALS**  
Dyed fabric, PVC  
and zinc plated metal



> specifications p. 55

	COLOURS	ENERGY CLASS	CODE	€ VAT EXCLUDED
Container	Nero	A <sup>+</sup> , A	LI4471-20E	625,00
Container h. 10 m •	Nero	A <sup>+</sup> , A	LI4471-20E10	674,20
<b>ACCESSORIES</b>				
Decentralization kit ◊	Canopy electrical decentralization		KIT DEC M	87,00

• On demand: lead times to be checked with the sales department

◊ Specifications see page 44



# FORK XL

Diesel Creative Team 2014

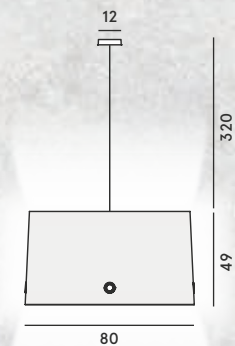

**LIGHT BULBS (NOT INCLUDED)**  
Max 3x105W E27

> specifications p. 55

**WEIGHT**  
net kg 4,00

**MATERIALS**  
Dyed linen, satin  
PMMA and varnished  
steel



	COLOURS	ENERGY CLASS	CODE	€ VAT EXCLUDED
Fork XL	Grigio	A <sup>+</sup> , A	LI0475-25-E3	1.167,64
	Avorio		LI0475-50-E3	
Fork XL h. 10 m •	Grigio	A <sup>+</sup> , A	LI0475-25-E10	1.220,45
	Avorio		LI0475-50-E10	

**ACCESSORIES**

Decentralization kit ◊	Decentralization for power cable	KIT DEC C	33,00
	Canopy electrical decentralization	KIT DEC M	87,00

• On demand: lead times to be checked with the sales department

◊ Specifications see page 44

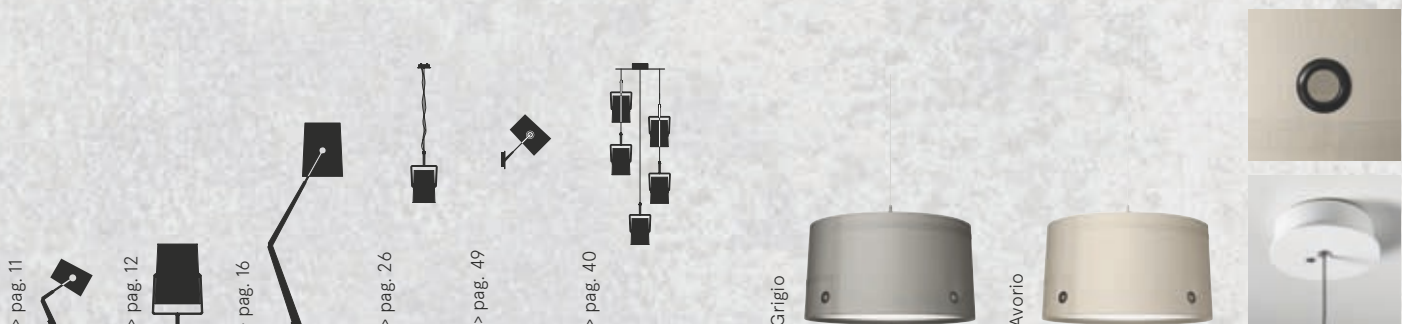

# FORK

Diesel Creative Team 2010

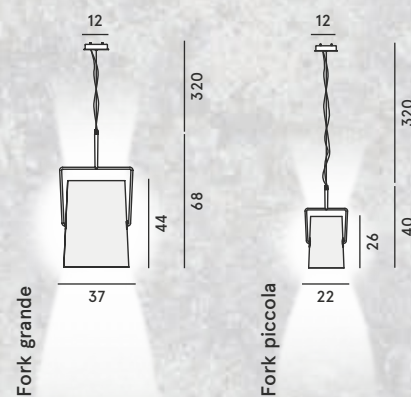

## LIGHT BULBS (NOT INCLUDED)

**Fork grande**  
Max 1x120W R7s (118mm)

**Fork piccola**  
Max 1x48W R7s (78mm)

> specifications p. 55

## WEIGHT

**Fork grande**  
net kg 2,50

**Fork piccola**  
net kg 1,40

## MATERIALS

Dyed linen,  
polycarbonate and  
coated steel

## CERTIFICATIONS



adjustable lampshade

	COLOURS	ENERGY CLASS	CODE	€ VAT EXCLUDED
<b>Fork grande</b>	Marrone/Grigio	A <sup>+</sup> , A, C	LI0471 25 E	<b>688,66</b>
	Marrone/Avorio		LI0471 50 E	
	Avorio/Grigio		LI0473 25 E	
	Avorio/Avorio		LI0473 50 E	
<b>Fork piccola</b>	Marrone/Grigio	A <sup>+</sup> , A, C	LI0472 25 E	<b>524,79</b>
	Marrone/Avorio		LI0472 50 E	
	Avorio/Grigio		LI0474 25 E	
	Avorio/Avorio		LI0474 50 E	
<b>Fork grande h. 10 m •</b>	Marrone/Grigio	A <sup>+</sup> , A, C	LI0471-25-E10	<b>741,46</b>
	Marrone/Avorio		LI0471-50-E10	
	Avorio/Grigio		LI0473-25-E10	
	Avorio/Avorio		LI0473-50-E10	
<b>Fork piccola h. 10 m •</b>	Marrone/Grigio	A <sup>+</sup> , A, C	LI0472-25-E10	<b>577,59</b>
	Marrone/Avorio		LI0472-50-E10	
	Avorio/Grigio		LI0474-25-E10	
	Avorio/Avorio		LI0474-50-E10	

• On demand: lead times to be checked with the sales department

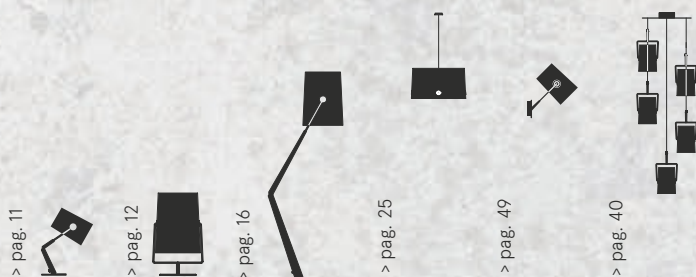

# FORK

Diesel Creative Team 2010

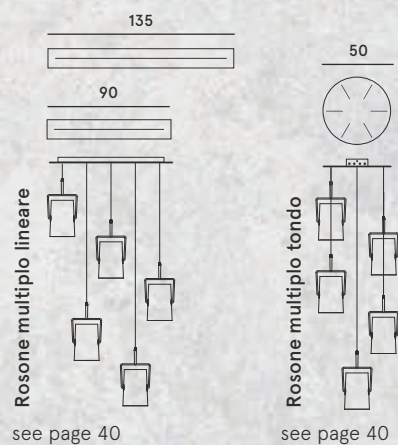

SPARE PARTS	COLOURS	ENERGY CLASS	CODE	€ VAT EXCLUDED
Lampshade Fork grande	Grigio		LI04DG 25 E	355,46
	Avorio		LI04DG 50 E	
Lampshade Fork piccola	Grigio		LI04DP 25 E	226,05
	Avorio		LI04DP 50 E	
<b>ACCESSORIES</b>				
Decentralization kit ◊	Decentralization for steel cables		KIT DEC B	28,00
	Decentralization for steel cables with canopy		KIT DEC F	49,00
	Canopy electrical decentralization		KIT DEC M	87,00

◊ Specifications see page 44



# GASK

Diesel Creative Team 2014

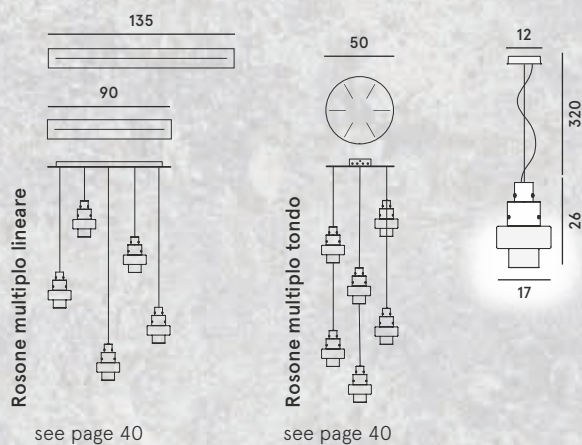

**LIGHT BULBS (NOT INCLUDED)**  
Max 1x46W E14

**WEIGHT**  
net kg 2,40

**MATERIALS**  
Blown glass and  
varnished steel



> specifications p. 55

	COLOURS	ENERGY CLASS	CODE	€ VAT EXCLUDED
Gask	Bianco	A <sup>+</sup> , A	LI3571 10 E1	283,20
	Grigio		LI3571 25 E1	
Gask h. 10 m •	Bianco	A <sup>+</sup> , A	LI3571-10E101	319,62
	Grigio		LI3571-25E101	
<b>SPARE PARTS</b>				
Glass Gask	Bianco		LI35VH 10 E	66,39
	Grigio		LI35VH 25 E	
<b>ACCESSORIES</b>				
Decentralization kit ◊	Decentralization for steel cables		KIT DEC B	28,00
	Decentralization for steel cables with canopy		KIT DEC F	49,00
	Canopy electrical decentralization		KIT DEC M	87,00

• On demand: lead times to be checked with the sales department

◊ Specifications see page 44

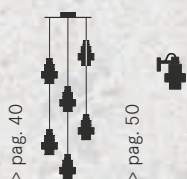

# GLAS

Diesel Creative Team 2009

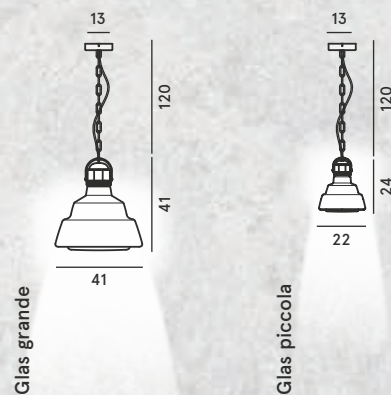

## LIGHT BULBS (NOT INCLUDED)

### Glas grande

Max 1x105W E27

## WEIGHT

### Glas grande

net kg 4,30

## MATERIALS

Metallized or sandblasted blown glass, thermoplastic material and nickel-plated steel

### Glas grande

⊕ CE IP 20

### Glas piccola

Max 1x21W E27

(Ø max 48 mm)

### Glas piccola

net kg 2,10

### Glas piccola

⊕ CE IP 20

> specifications p. 55

	COLOURS	ENERGY CLASS	CODE	€ VAT EXCLUDED
Glas grande	Cromo	A <sup>+</sup> , A	LI0171 78 E	794,11
	Bianco		LI0171 10 E	626,05
Glas piccola	Cromo	A <sup>+</sup> , A	LI0172 78 E	500,84
	Bianco		LI0172 10 E	389,91
Glas grande h. 5 m •	Cromo	A <sup>+</sup> , A	LI0171 78 E5	836,13
	Bianco		LI0171 10 E5	668,07
Glas piccola h. 5 m •	Cromo	A <sup>+</sup> , A	LI0172 78 E5	538,66
	Bianco		LI0172 10 E5	427,73

## SPARE PARTS

Glass Glas grande	Cromo	LI01VG 78 E	506,72
	Bianco	LI01VG 10 E	338,66
Glass Glas piccola	Cromo	LI01VP 78 E	245,38
	Bianco	LI01VP 10 E	134,45

## ACCESSORIES

Decentralization kit ◊	Canopy electrical decentralization	KIT DEC M	87,00
------------------------	------------------------------------	-----------	-------

• On demand: lead times to be checked with the sales department

◊ Specifications see page 44

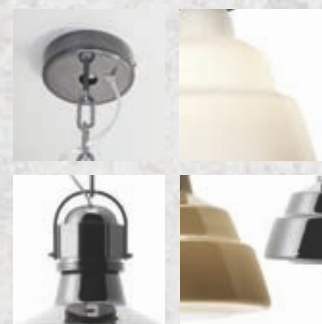

# GLASS DROP

Diesel Creative Team 2013

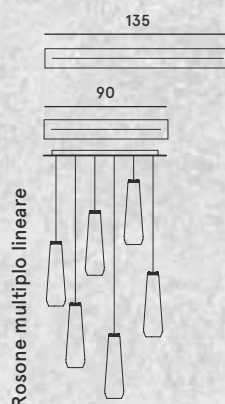

see page 40

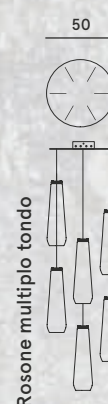

see page 40



**LIGHT BULBS (NOT INCLUDED)**  
Max 1x57W E27

> specifications p. 55

**WEIGHT**  
net kg 1,80

**MATERIALS**  
Metallized  
blown glass and  
thermoplastic  
material



	COLOURS	ENERGY CLASS	CODE	€ VAT EXCLUDED
Glass Drop	Cromo	A <sup>+</sup> , A, C	LI3007-78-E1	447,90
	Bianco		LI3007-10-E1	338,66
Glass Drop h. 10 m •	Cromo	A <sup>+</sup> , A, C	LI3007-78E101	495,24
	Bianco		LI3007-10E101	386,00
<b>SPARE PARTS</b>				
Glass Glass Drop	Cromo		LI30V 78 E	289,08
	Bianco		LI30V 10 E	179,83
<b>ACCESSORIES</b>				
Decentralization kit ◊	Decentralization for steel cables		KIT DEC B	28,00
	Decentralization for steel cables with canopy		KIT DEC F	49,00
	Canopy electrical decentralization		KIT DEC M	87,00

• On demand: lead times to be checked with the sales department

◊ Specifications see page

> pag. 13



> pag. 40



Cromo



Bianco



on



off



Cromo



Bianco





# METAL GLASS

Diesel Creative Team 2012

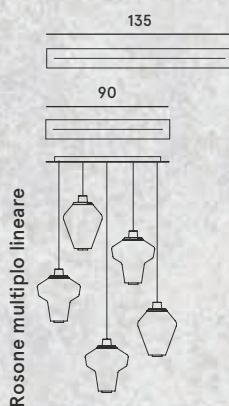

see page 40

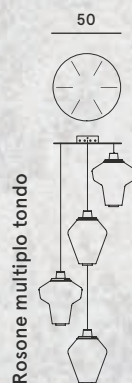

see page 40

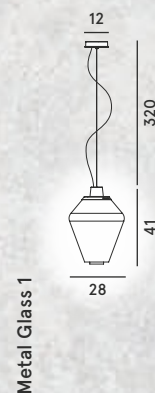

Metal Glass 1

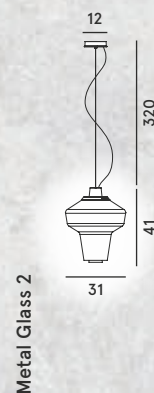

Metal Glass 2

**LIGHT BULBS (NOT INCLUDED)**  
Max 1x105W E27

> specifications p. 55

**WEIGHT**  
**Metal Glass 1**  
net kg 3,50

**Metal Glass 2**  
net kg 3,80

**MATERIALS**  
Blown glass, Pyrex  
and lacquered steel



	COLOURS	ENERGY CLASS	CODE	€ VAT EXCLUDED
<b>Metal Glass 1</b>	Grigio*	A <sup>+</sup> , A	LI2271 25 E	577,30
	Ambra*		LI2271 52 E	
<b>Metal Glass 2</b>	Grigio*	A <sup>+</sup> , A	LI2272 25 E	577,30
	Verde*		LI2272 40 E	
<b>SPARE PARTS</b>				
Glass Metal Glass 1	Grigio		LI22V3 25 E	235,29
	Ambra		LI22V3 52 E	
Glass Metal Glass 2	Grigio		LI22V4 25 E	235,29
	Verde		LI22V4 40E	
<b>ACCESSORIES</b>				
Decentralization kit ◊	Decentralization for steel cables		KIT DEC B	28,00
	Decentralization for steel cables with canopy		KIT DEC F	49,00
	Canopy electrical decentralization		KIT DEC M	87,00

◊ Specifications see page 44

\* limited stock available



> pag. 40



# MYSTERIO

Diesel Creative Team 2011

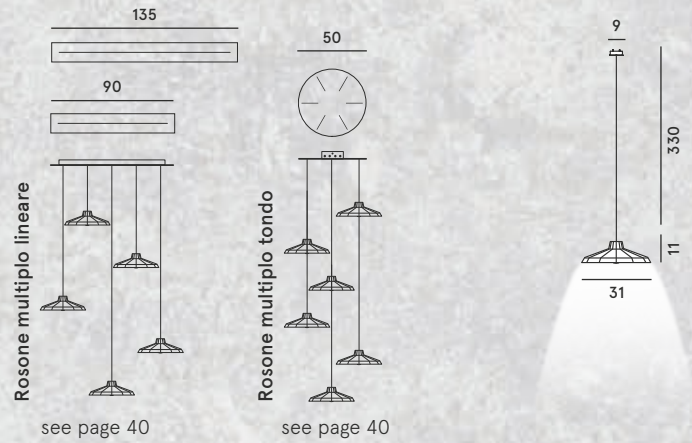

**LIGHT BULBS (NOT INCLUDED)**  
Max 1x33W G9

**WEIGHT**  
net kg 0,80

**MATERIALS**  
Metallized batch-dyed polycarbonate and blown glass



> specifications p. 55

	COLOURS	ENERGY CLASS	CODE	€ VAT EXCLUDED
Mysterio	Bianco-rame	A <sup>+</sup> , A, C	LI1971-10-E2	210,08
	Nero-argento		LI1971-20-E2	
Mysterio h. 10 m •	Bianco-rame	A <sup>+</sup> , A, C	LI1971-10E102	246,51
	Nero-argento		LI1971-20E102	

**ACCESSORIES**

Decentralization kit ◊	Decentralization for power cable	KIT DEC C	33,00
	Canopy electrical decentralization	KIT DEC M	87,00

- On demand: lead times to be checked with the sales department
- ◊ Specifications see page



> pag. 46

> pag. 46

> pag. 40

Bianco-rame

Nero-argento

Bianco-rame

Nero-argento

# PYLON

Diesel Creative Team 2014



**LIGHT BULBS (NOT INCLUDED)**  
Max 1x116W E27

> specifications p. 55

**WEIGHT**  
net kg 1,80

**MATERIALS**  
Dyed linen, PVC and  
varnished steel



	COLOURS	ENERGY CLASS	CODE	€ VAT EXCLUDED
<b>Pylon</b>	Avorio*	A <sup>+</sup> , A	LI3771 50 E	692,86
<b>SPARE PARTS</b>				
Lampshade Pylon	Avorio		LI37D 50 E	563,03
<b>ACCESSORIES</b>				
Decentralization kit ◊	Decentralization for steel cables		KIT DEC B	28,00
	Decentralization for steel cables with canopy		KIT DEC F	49,00
	Canopy electrical decentralization		KIT DEC M	87,00

◊ Specifications see page 44

\* limited stock available

> pag. 18



Avorio\*



# ROCK

Diesel Creative Team 2009

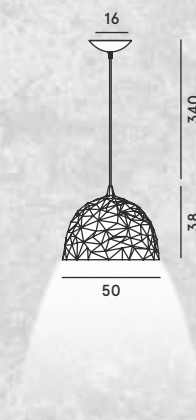
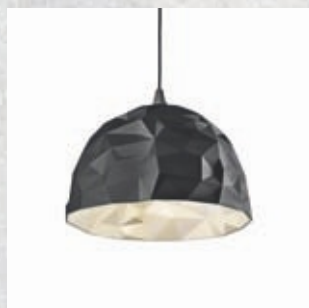

#### LIGHT BULBS (NOT INCLUDED)

Max 1x23W E27

Recommended white globe bulb Ø 12 cm

> specifications p. 55

#### WEIGHT

net kg 2,30

#### MATERIALS

Moulded coated ABS  
+ polycarbonate



	COLOURS	ENERGY CLASS	CODE	€ VAT EXCLUDED
<b>Rock</b>	Bianco	A <sup>+</sup> , A	LI0507-10-E31	459,24
	Nero		LI0507-52-E31	
	Oro		LI0507-50-E31	
<b>Rock h. 10 m •</b>	Bianco	A <sup>+</sup> , A	LI0507-10E101	482,93
	Nero		LI0507-52E101	
	Oro		LI0507-50E101	
<b>ACCESSORIES</b>				
Decentralization kit ◊	Decentralization for power cable		KIT DEC C	33,00
	Canopy electrical decentralization		KIT DEC M	87,00

• On demand: lead times to be checked with the sales department

◊ Specifications see page 44

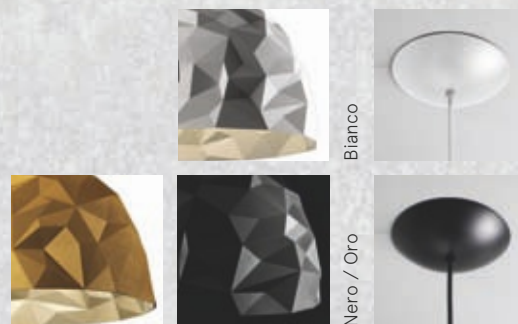

# SMASH

Diesel Creative Team 2016

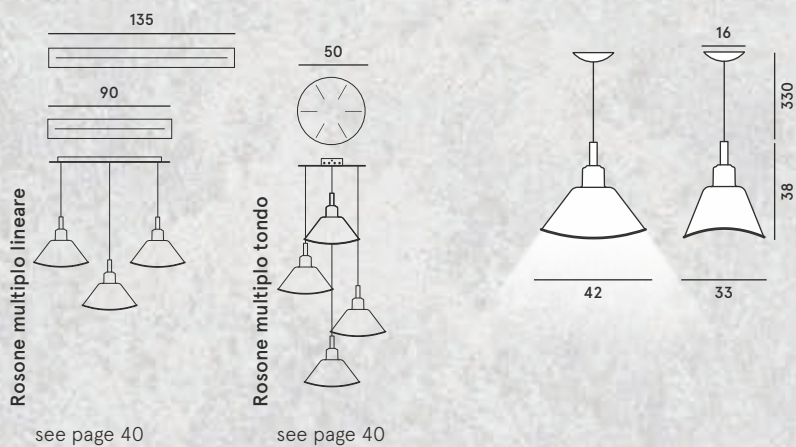

**LIGHT BULBS (NOT INCLUDED)**  
Max 1x57W E27

> specifications p. 55

**WEIGHT**  
net kg 1,80

**MATERIALS**  
Pressed glass,  
aluminium, steel and  
laquered metal



	COLOURS	ENERGY CLASS	CODE	€ VAT EXCLUDED
Smash	Grigio	A <sup>+</sup> , A	LI4171-25-E1	459,24
	Rust		LI4171-52-E1	
Smash h. 10 m •	Grigio	A <sup>+</sup> , A	LI4171-25E101	482,93
	Rust		LI4171-52E101	
<b>ACCESSORIES</b>				
Decentralization kit ◊	Decentralization for power cable		KIT DEC C	33,00
	Canopy electrical decentralization		KIT DEC M	87,00

• On demand: lead times to be checked with the sales department

◊ Specifications see page 44

> pag. 51

> pag. 40

Grigio



Rust



## SPACE FAB

Diesel Creative Team 2018

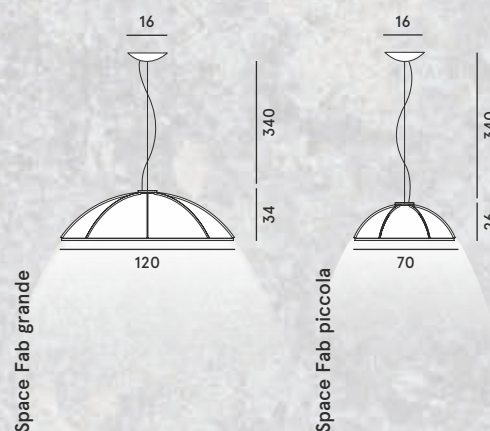

**LIGHT BULBS (NOT INCLUDED)**  
Max 1x25W E27

**PESO**  
**Space Fab grande**  
net kg 1,00

**Space Fab piccola**  
net kg 0,80

**MATERIALS**  
Technical fabric  
and cotton fabric  
coupled with  
aluminium, steel and  
plastic



The imperfections on the fabric – which can become visible, lighting up on the outer part – should be considered a virtue, not a defect: the expression of the force and character of this lamp and the language of Diesel

	COLOURS	ENERGY CLASS	CODE	€ VAT EXCLUDED
<b>Space Fab grande</b>	Argento opaco	A <sup>+</sup>	LI4571-10E	451,00
<b>Space Fab piccola</b>	Argento opaco	A <sup>+</sup>	LI4572-10E	402,00
<b>Space Fab grande h. 10 m •</b>	Argento opaco	A <sup>+</sup>	LI4571-10E10	518,36
<b>Space Fab piccola h. 10 m •</b>	Argento opaco	A <sup>+</sup>	LI4572-10E10	469,36
<b>ACCESSORIES</b>				
Decentralization kit ◊	Decentralization for steel cables		KIT DEC B	28,00

- On demand: lead times to be checked with the sales department
- ◊ Specifications see page 44

Grande argento



Piccola argento

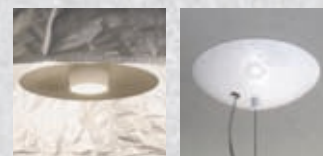

# TOOL

Diesel Creative Team 2010

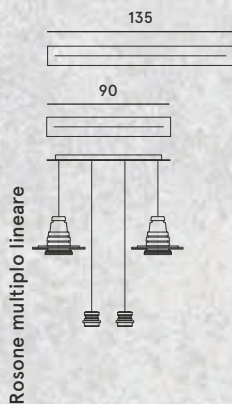

see page 40

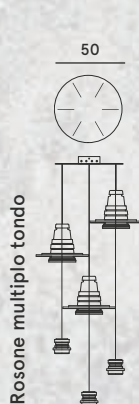

see page 40

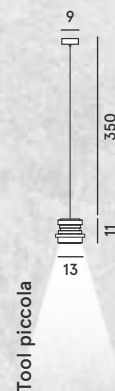
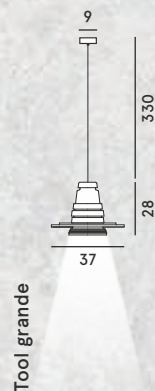

**LIGHT BULBS (NOT INCLUDED)**

**Tool grande**  
Max 1x60W G9

**Tool piccola**  
Max 1x35W GU10 PAR 30

> specifications p. 55

**WEIGHT**  
**Tool grande**  
net kg 2,50

**Tool piccola**  
net kg 0,60

**MATERIALS**  
Colored  
polyurethane and  
aluminium



	COLOURS	ENERGY CLASS	CODE	€ VAT EXCLUDED
<b>Tool grande</b>	Nero	A <sup>+</sup> , A, C	LI0971-20-E1	284,88
<b>Tool piccola</b>	Nero	A <sup>+</sup> , A, C	LI0972-20-E1	171,43
<b>Tool grande h. 10 m •</b>	Nero	A <sup>+</sup> , A, C	LI0971-20E101	321,30
<b>Tool piccola h. 10 m •</b>	Nero	A <sup>+</sup> , A, C	LI0972-20E101	207,83

**ACCESSORIES**

Decentralization kit ◊	Decentralization for power cable	KIT DEC C	33,00
	Canopy electrical decentralization	KIT DEC M	87,00

• On demand: lead times to be checked with the sales department

◊ Specifications see page 44

> pag. 40



# WHITE NOISE



Diesel Creative Team 2016

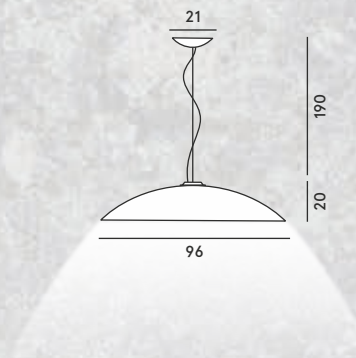

#### LED INCLUDED

46W COB 3000 K 4312 lm CRI>90

#### WEIGHT

net kg 12,30

#### MATERIALS

Varnished aluminium and ABS



Dimmable Version possible configurations:  
On-Off /Push/DALI

	COLOURS	ENERGY CLASS	CODE	€ VAT EXCLUDED
White Noise	Nero	A	LI4007 20 E	1.564,28
White Noise dimmable	Nero	A	LI4007D 20 E	1.626,46
White Noise h. 10 m •	Nero	A	LI4007-20-E10	1.631,65
White Noise dimmable h. 10 m •	Nero	A	LI4007D-20E10	1.693,83
<b>ACCESSORIES</b>				
Decentralization kit ◊	Decentralization for steel cables		KIT DEC B	28,00

• On demand: lead times to be checked with the sales department

◊ Specifications see page 44





# WRECKING BALL

Diesel Creative Team 2018

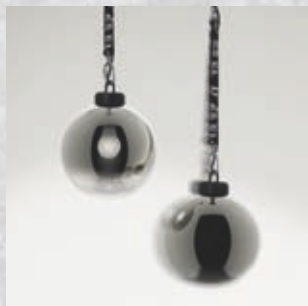

## LIGHT BULBS (NOT INCLUDED)

Max 1x25W E27

> specifications p. 55

## MATERIALS

Metalized pyrex glass,  
metal and technical  
fabric

⊕ CE IP 20

	COLOURS	ENERGY CLASS	CODE	€ VAT EXCLUDED
<b>Wrecking Ball</b>	Cromo	A+	LI4871-78E	402,00
<b>SPARE PARTS</b>				
Glass Wrecking Ball	Cromo		LI48D-78E	196,98

Cromo



on



off

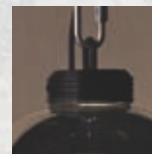

## ACCESSORIES: MULTIPLE CANOPIES



### ROUND

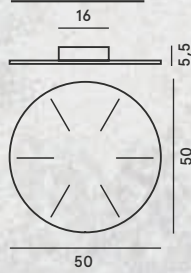

**Round multiple canopy**  
Lacquered metal  
Max 30kg

**WEIGHT**  
net kg 9,00



### LINEAR

**Linear multiple canopy 90**  
Lacquered metal  
Max 30kg

**WEIGHT**  
net kg 7,00

**Linear multiple canopy 135**  
Lacquered metal  
Max 30kg

net kg 10,00

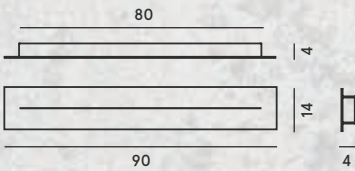

Linear multiple canopy 90

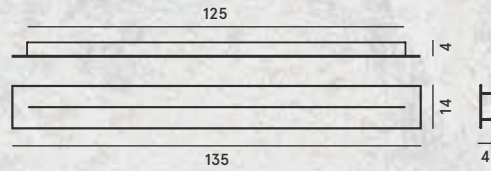

Linear multiple canopy 135

### ADVICE ON INSTALLATION

MODEL	ROUND MULTIPLE CANOPY	LINEAR MULTIPLE CANOPY 90	LINEAR MULTIPLE CANOPY 135
Cage piccola	max 6	max 6	max 9
Cage Mic	max 9	max 5	max 7
Fork piccola	max 6	max 6	max 9
Glass Drop	max 9	max 6	max 9
Gask	max 9	max 5	max 9
Metal Glass 1	max 6	max 6	max 9
Metal Glass 2	max 6	max 5	max 8
Mysterio	max 6	max 5	max 8
Smash	max 6	max 5	max 7
Tool grande	max 6	max 5	max 7
Tool piccola	max 9	max 6	max 9

Max. refers to installation in staggered composition

ACCESSORIES	COLOURS	CODE	€ VAT EXCLUDED
Round multiple canopy	Bianco	ROSONE01D 10	415,13
Linear multiple canopy 90	Bianco	ROSONE02D 10	348,74
Linear multiple canopy 135	Bianco	ROSONE03D 10	463,87

## MULTIPLE COMPOSITIONS

A technical solution combining practicality and harmony of form. Foscarini's multiple rosettes give you the chance to create large effect compositions of up to nine hanging lamps. In the round rosette lamps can be positioned at different heights to make a light waterfall. Linear rosettes are available in two sizes - 90 or 135 cm (35 7/16" or 53 5/32") - and can be used alone or in sequence to create rows of various lengths.

SMASH



CAGE



CAGE MIC



FORK PICCOLA



TOOL



GLASS DROP



METAL GLASS



GLASS DROP



MYSTERIO



GASK



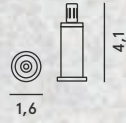

ACCESSORIES:DECENTRALIZATION KITKIT B**Kit B**

Decentralization for steel cables  
includes 3 steel cable supports

For the models:

**Bell - Cage grande-piccola - Crash - Fork - Gask - Glass  
Drop - Metal Glass - Pylon - Space Fab**

KIT C**Kit C**

Decentralization for power cable



For the models:

**Cage Mic - Fork XL - Mysterio - Rock - Smash - Tool**

**ACCESSORIES**

Decentralization for steel cables  
Decentralization for power cable

**CODE**

KIT DEC B  
KIT DEC C

**€ VAT EXCLUDED**

**28,00**  
**33,00**

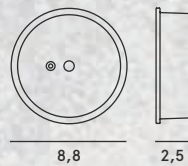
ACCESSORIES:DECENTRALIZATION KITKIT F**Kit F**

Decentralization for steel cables  
includes 3 steel cable supports and a white canopy



For the models:

**Bell - Cage grande-piccola - Crash - Fork - Gask - Glass Drop - Metal Glass - Pylon**

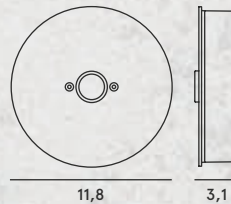
KIT M**Kit M**

Canopy electrical decentralization up to 4 lamps.

The kit M contains only the canopy, for compositions in the pictures order the necessary quantity of Kit B or Kit C.



For the models:

**Bell - Cage grande-piccola-Mic - Crash - Container Fork-XL - Gask - Glas - Glass Drop - Metal Glass Mysterio - Rock - Smash - Tool - Pylon**

ACCESSORIES

Decentralization for steel cables with canopy  
Canopy electrical decentralization

CODE

KIT DEC F  
KIT DEC M

€ VAT EXCLUDED

49,00  
87,00

# MYSTERIO

Diesel Creative Team 2011

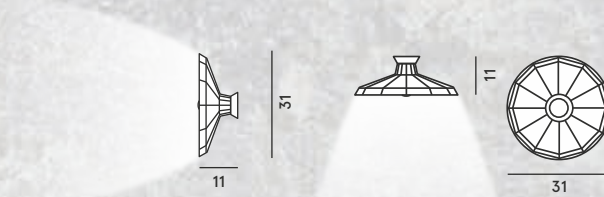

**LIGHT BULBS (NOT INCLUDED)**  
Max 1x33W G9

> specifications p. 55

**WEIGHT**  
net kg 0,80

**MATERIALS**  
Metallized batch-dyed polycarbonate and blown glass

 **CE** IP 20

	COLOURS	ENERGY CLASS	CODE	€ VAT EXCLUDED
Mysterio	Bianco-rame	A <sup>+</sup> , A, C	LI1951 10 E1	200,00
	Nero-argento		LI1951 20 E1	

> pag. 32



Bianco-rame



Nero-argento





**VENT****LED**

Diesel Creative Team 2017

**LED INCLUDED**

12,5W Acrich 2700 K  
1130 lm CRI>80  
dimmable with TRIAC technology

**WEIGHT**

net kg 0,80

**MATERIALS**

Varnished  
aluminium, metal  
and polycarbonate



	COLOURS	ENERGY CLASS	CODE	€ VAT EXCLUDED
Vent	Bianco	A <sup>+</sup>	LI4251 10 E	415,97
	Oro		LI4251 50 E	445,38

bianco



oro



## DUII MINI

Diesel Creative Team 2012

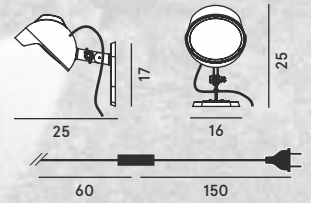

**LIGHT BULBS (NOT INCLUDED)**  
Max 1x10W R7s (78mm)

> specifications p. 55

**WEIGHT**  
net kg 1,40

**MATERIALS**  
Pressed glass,  
aluminium, steel and  
laquered metal



adjustable lampshade,  
with personalized packaging

	COLOURS	ENERGY CLASS	CODE	€ VAT EXCLUDED
Duii mini	Grigio	A <sup>+</sup> , A	L11812 25 E1	294,12
	Giallo		L11812 50 E1	

> pag. 10



> pag. 10



Giallo



Grigio



# FORK

Diesel Creative Team 2013

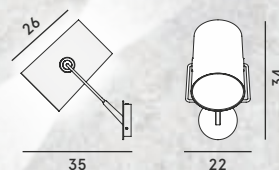

**LIGHT BULBS (NOT INCLUDED)**  
Max 1x48W R7s (78mm)

> specifications p. 55

**WEIGHT**  
net kg 1,20

**MATERIALS**  
Dyed linen,  
polycarbonate and  
coated steel



adjustable lampshade

	COLOURS	ENERGY CLASS	CODE	€ VAT EXCLUDED
<b>Fork</b>	Marrone/Grigio	A <sup>+</sup> , A, C	LI0451 25 E	539,50
	Marrone/Avorio		LI0451 50 E	
	Avorio/Grigio		LI0452 25 E	
	Avorio/Avorio		LI0452 50 E	
<b>SPARE PARTS</b>				
	Lampshade Fork	Grigio	LI04DP 25 E	226,05
		Avorio	LI04DP 50 E	

> pag. 11



> pag. 12



> pag. 16



> pag. 26



> pag. 25



> pag. 40



Marrone/Grigio



Marrone/Avorio



Avorio/Grigio



Avorio/Avorio



# GASK

Diesel Creative Team 2012

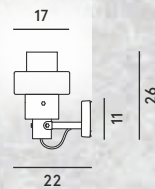
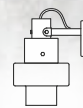

**LIGHT BULBS (NOT INCLUDED)**  
Max 1x46W E14

**WEIGHT**  
net kg 2,5



> specifications p. 55

	COLOURS	ENERGY CLASS	CODE	€ VAT EXCLUDED
<b>Gask</b>	Bianco	A <sup>+</sup> , A	LI3551 10 E	378,15
	Grigio		LI3551 25 E	
<b>RICAMBI</b>				
Glass Gask	Bianco		LI35VH 10 E	66,39
	Grigio		LI35VH 25 E	

> pag. 28



bianco



grigio



# SMASH

Diesel Creative Team 2016

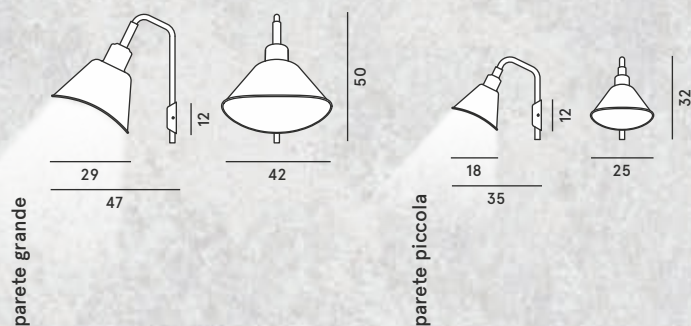

**LIGHT BULBS (NOT INCLUDED)**  
Max 1x57W E27

> specifications p. 55

**WEIGHT**  
**Smash grande**  
net kg 2,00

**Smash piccola**  
net kg 1,80

**MATERIALS**  
Varnished  
aluminium and  
metal



PARETE	COLOURS	ENERGY CLASS	CODE	€ VAT EXCLUDED
Smash grande	Grigio	A <sup>+</sup> , A	LI4151 25 E	630,25
	Rust		LI4151 52 E	
Smash piccola	Grigio	A <sup>+</sup> , A	LI4152 25 E	495,80
	Rust		LI4152 52 E	
Smash grande with plug *	Grigio	A <sup>+</sup> , A	LI4151S 25 E	656,30
	Rust		LI4151S 52 E	
Smash piccola with plug *	Grigio	A <sup>+</sup> , A	LI4152S 25 E	521,85
	Rust		LI4152S 52 E	

\* on demand version with external cable, switch and plug

> pag. 35

> pag. 40

grigio

rust

grigio with plug

rust with plug

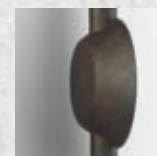

# PACKING

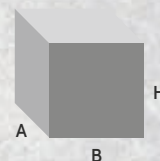

Model	Version	N° boxes	Description	Net weight kg	Gross weight kg	Size cm	A x B x H	
Bell	Sospensione	1	diffuser	1,1	2,6	50	50 x 30	
		1	frame	1,1	1,6	31	22 x 23	
Cage	grande	Sospensione	1	glass	3,2	3,7	41	41 x 46
			1	cage	0,7	2,9	47	47 x 44
		1	frame	0,6	2,5	76	18 x 18	
	piccola	Sospensione	1	cage	0,4	2,3	36	36 x 34
			1	frame	0,6	2,3	76	18 x 18
			1	glass	2,0	2,2	31	31 x 36
	Mic	Sospensione	1	1,3	2,1	23	32 x 37	
Crash	Sospensione	1	diffuser	1,1	3,5	75	75 x 12	
		1	frame	1,1	1,6	31	22 x 23	
Container	Sospensione	1		10,0	13,0	95	48 x 41	
Duii	Tavolo	1		4,1	6,3	43	25 x 32	
Duii Mini	Tavolo/Parete	1		1,4	2,5	32	23 x 27	
Fork	grande	Sospensione	1	diffuser	0,5	1,8	35	35 x 47
			1	frame	2,0	2,5	56	45 x 9
		Terra	1	diffuser	0,5	1,8	35	35 x 47
			1	frame	11,0	18,5	176	47 x 18
	piccola	Sospensione	1	diffuser	0,3	0,7	20	20 x 29
			1	frame	1,1	1,3	37	25 x 8
		Parete	1	diffuser	0,3	0,7	20	20 x 29
			1	frame	0,9	2,2	38	25 x 29
	Tavolo	1	diffuser	0,3	0,7	20	20 x 29	
		1	frame	2,1	3,7	59	25 x 30	
	maxi	Tavolo	1	diffuser	0,5	1,8	35	35 x 47
			1	frame	3,3	4,0	45	45 x 8
	XL	Sospensione	1	diffuser	3,0	4,0	84	84 x 25
			1	frame	1,0	1,8	28	27 x 23
Gask	Parete	1	glass	1,0	1,5	25	25 x 27	
		1	frame	1,4	1,8	24	20 x 26	
	Sospensione	1	glass	1,0	1,5	25	25 x 27	
		1	frame	1,4	1,8	18	18 x 27	
Glas	grande	Sospensione	1	glass	3,7	5,8	48	48 x 46
			1	frame	0,6	2,3	31	26 x 18
	piccola	Sospensione	1	glass	1,5	2,2	28	28 x 26
			1	frame	0,6	1,5	26	26 x 18
Glass Drop	Sospensione	1		1,8	2,8	58	20 x 19	
	Tavolo	1		7,9	10,7	49	49 x 55	
Hexx	Tavolo	1		6,5	10,6	50	40 x 60	
Metafisica	Tavolo	1	glass	3,7	5,8	48	48 x 40	
		1	frame	1,3	2,0	29	29 x 43	
Metal Glass	1	Sospensione	1	glass	2,6	4,2	41	41 x 30
			1	frame	0,9	2,0	43	33 x 20
	2	Sospensione	1	glass	3,6	4,2	41	41 x 30
			1	frame	0,9	2,0	43	33 x 20
Mysterio	Parete/Soffitto	1		0,8	2,1	39	39 x 19	
	Sospensione	1		0,8	2,1	39	39 x 19	
Pipe	grande	Terra	1	upper diffuser	2,1	5,3	78	62 x 62
			1	lower diffuser	1,9	6,4	118	38 x 38
			1	frame	4,5	6,4	48	48 x 16
	media	Terra	1	upper diffuser	2,6	4,8	74	74 x 49
			1	lower diffuser	1,9	6,4	118	38 x 38
			1	frame	4,5	6,7	48	48 x 16
Pylon	Sospensione	1	diffuser	1,5	4,5	60	60 x 56	
		1	frame	0,3	0,6	19	19 x 14	
	Terra	1	frame	7,3	10,0	108	48 x 48	
		1	diffuser	1,5	4,5	60	60 x 56	
Rock	Sospensione	1		2,3	5,3	53	53 x 43	
Smash	Sospensione	1		1,8	2,5	49	40 x 47	
	grande	Parete	1	2,0	2,9	59	49 x 52	
	piccola	Parete	1	1,8	2,7	47	31 x 36	

Model		Version	N° boxes	Description	Net weight kg	Gross weight kg	Size cm	A x B x H
<b>Tank</b>		Terra	<b>2</b>	diffuser	2,0	3,0	48	48 84
			<b>1</b>	frame	6,0	8,0	52	46 123
<b>Tool</b>	<b>grande</b>	Sospensione	<b>1</b>		2,5	3,6	41	41 30
	<b>piccola</b>	Sospensione	<b>1</b>		0,6	0,9	14	14 16
<b>Vent</b>		Parete	<b>1</b>		0,8	2,1	49	49 19
<b>Whitenoise</b>		Sospensione	<b>1</b>	diffuser	11,4	12,4	109	27 107
			<b>1</b>	canopy	1,0	1,9	24	24 9
<b>Rosone multiplo</b>	<b>tondo</b>		<b>1</b>		9,0	10,7	61	61 9
	<b>lineare 90 cm</b>		<b>1</b>		6,8	7,7	100	27 9
	<b>lineare 135 cm</b>		<b>1</b>		10,0	11,5	145	27 9





## LIGHT SOURCES

**Halogen bulbs:** Starting from September 1st 2018, according to a European directive, some halogen light bulbs have been banned. This does not mean that they will no longer be sold, since they can be sold in stores until stocks run out. Directional halogen lamps (spotlights) and those with R7s - G9 and G4 lamp holders will continue to be available and sold.



If the use of a retrofit LED bulb in the lamp with lamp holder R7s is chosen, the supplied Pyrex protection glass must be removed.

**Lamps with dimmer:** Please verify the compatibility of your bulb with the dimmer's wattage ranges, indicated on the dimmer itself, according to the kind of light source.

**LED retrofit light bulbs:** Foscarini recommends the use of warm light bulbs for its whole collection. The light bulbs available on the market may feature technical specifications with various graphics and definitions, but a warm light tone is generally described as Warm White - 2700- 3000K\* and CRI > 80.

This table contains the necessary information to purchase the correct light source (models with integrated LED excluded).

\* Expressed in mm

Model	Version	Type	Fitting base	Lenght*	Width*	Notes
Bell-Crash	sospensione	LED retrofit o FLUO/HALO	E27	max 140	max Ø60	
Cage Grande	sospensione	LED retrofit o FLUO/HALO	E27	max 120		
Cage mic	sospensione	LED retrofit/HALO	G9			
Cage Piccola	sospensione	LED retrofit o FLUO/HALO	E27	max 120		
Container	sospensione	LED retrofit	E27	max140	max Ø80	
Duii - Dui Mini	tavolo/parete (mini)	LED retrofit	R7s	78	max Ø25	
Fork Maxi/Terra/Grande	tavolo/terra/sospensione	LED retrofit/HALO	R7s	118		
Fork Tavolo/Piccola/Parete	tavolo/sospensione/parete	LED retrofit/HALO	R7s	78		
Fork XL	sospensione	LED retrofit o FLUO/HALO	E27			
Gask	sospensione	LED retrofit o FLUO/HALO	E14	max 80	max Ø70	
Glas Grande	sospensione	LED retrofit o FLUO/HALO	E27	180	max Ø70	
Glas Piccola	sospensione	LED retrofit o FLUO	E27	150	max Ø48	
Glass Drop Sospensione	sospensione	LED retrofit o FLUO/HALO	E27	150	max Ø85	
Glass Drop Tavolo	tavolo	LED retrofit dimmer. /HALO	E27	150	max Ø140	
Hexx	tavolo	LED retrofit o FLUO/HALO	E27 PAR		max Ø150	
Metafisica	tavolo	LED retrofit dimmer. /HALO	E27		max Ø100	
Metal Glass	tavolo/sospensione	LED retrofit o FLUO/HALO	E27		max Ø67	
Mysterio	sospensione/soffitto/parete	HALO o LED retrofit	G9	max 60	max Ø20	
Pipe terra	terra	LED retrofit dimmer. /HALO	E27			
Pylon sospensione	sospensione	LED retrofit o FLUO/HALO	E27			
Pylon Terra	terra	LED retrofit dimmer. /HALO	E27			
Rock	sospensione	LED retrofit o FLUO	E27		Ø120	whiteglobe bulb recommended
Space Fab	sospensione	LED retrofit	E27			
Tank	terra	LED retrofit dimmer. /HALO	E27			
Tool Grande	sospensione	LED retrofit dimmer. /HALO	G9	max Ø60	max Ø20	
Tool Piccola	sospensione	LED retrofit/HALO	GU10-PAR	max 80	max Ø55	
Wrecking Ball	sospensione	LED retrofit	E27	max Ø70		

Foscarini SpA  
via delle Industrie 27  
30020 Marcon / Venezia /Italy  
T +39 041 595 3811  
F +39 041 595 3820  
foscarini@foscarini.com

edition 11.2018

Photography:  
Massimo Gardone /Azimut  
Giuliano Koren  
Sasha Oda  
Shooting by Diesel

Foscarini Inc  
20 Greene Street, New York  
NY /10013 / USA  
T +1 212 247 2218  
F +1 646 545 2564  
foscarini.inc@foscarini.com

made and printed in Italy  
Grafiche GFP

foscarini.com

Foscarini Japan K.K.  
Oak Minami-Azabu  
Building, 19-23,  
Minami-Azabu 3-chome,  
106-0047 Minato-ku  
Tokyo / Japan  
foscarini.jpn@foscarini.com

Foscarini Spazio Monforte  
Corso Monforte 19  
20122 / Milano / Italy  
T +39 02 870 71320  
spaziomonforte@foscarini.com

Foscarini Spazio Soho  
20 Greene Street, New York  
NY /10013 / USA  
T +1 212 257 4412  
spaziosoho@foscarini.com

Azienda certificata  
UNI EN ISO 9001:2015  
UNI EN ISO 14001:2015



